

# BE-IIS-HAT++T1S-Rev.B

## Brechel Electronic

### Industrie Interface Solutions

[www.be-iis.eu](http://www.be-iis.eu)

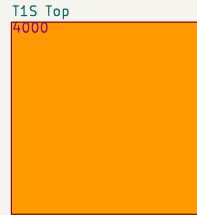

File: T1S\_TOP.kicad\_sch

Brechel Electronic  
Industrial Interface Solutions  
Designed by Philipp Brechel (Germany)  
[www.be-iis.eu](http://www.be-iis.eu)  
[contact@be-iis.eu](mailto:contact@be-iis.eu)

Sheet: /  
File: BRECHEL\_HAT\_T1S.kicad\_sch

**Title: Pi-HAT+: T1S**

Size: A4 Date: 2026-03-25

KiCad E.D.A. 9.0.7

**Rev: B**

Id: 1/6

# HAT+ EEprom

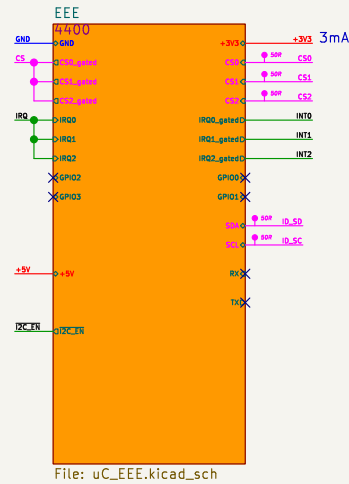

# T1S

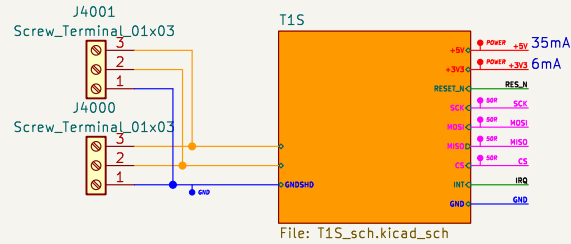

# Pi Pinout

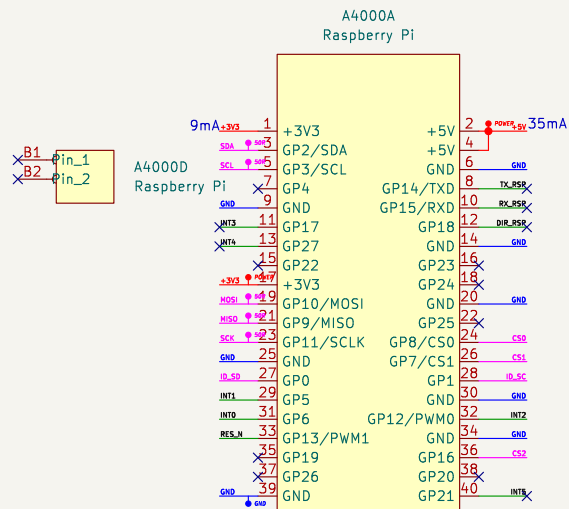

# I2C Pullups



**Brechel Electronic**  
 Industrial Interface Solutions  
 Designed by Philipp Brechel (Germany)  
[www.be-iis.eu](http://www.be-iis.eu)  
[contact@be-iis.eu](mailto:contact@be-iis.eu)

Sheet: /T1S Top/  
 File: T1S\_TOP.kicad\_sch

**Title: Pi-HAT+ T1S**

Size: A4 Date: 2026-03-25

KiCad E.D.A. 9.0.7

Rev: B

Id: 9/6



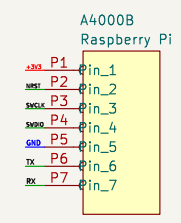
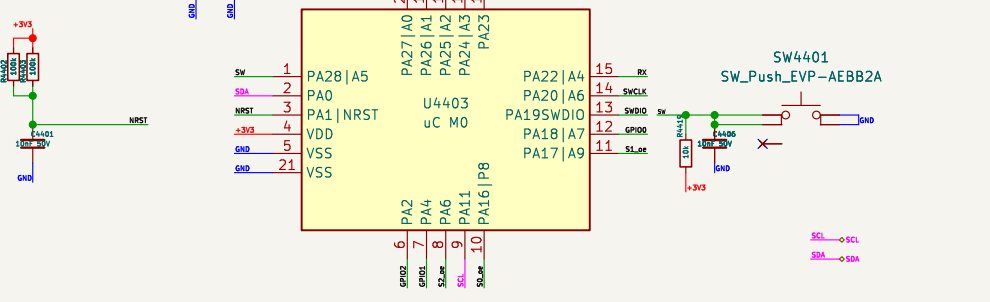
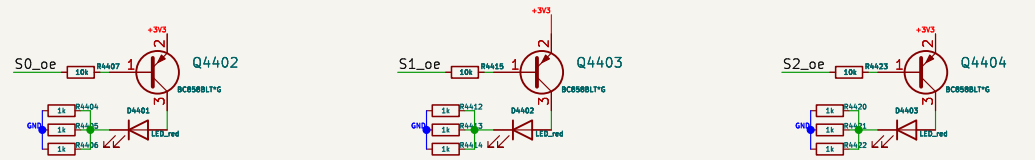
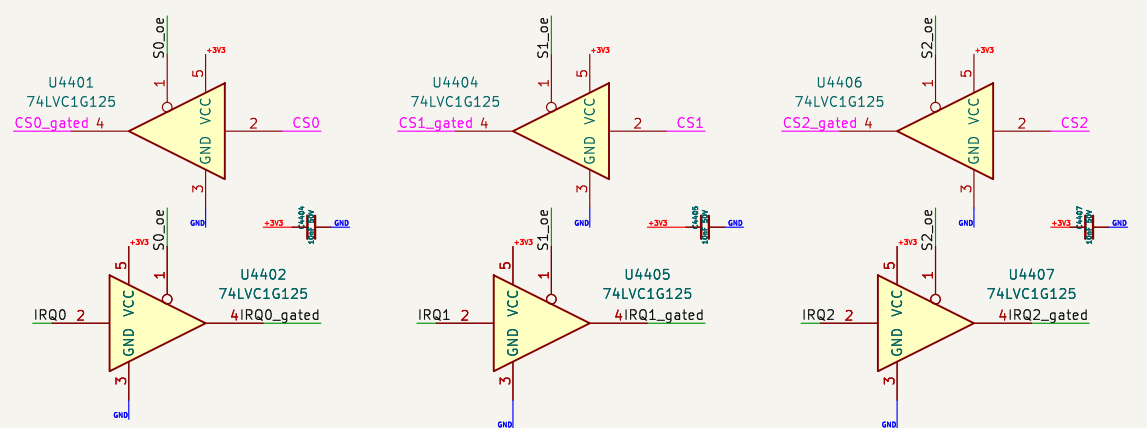
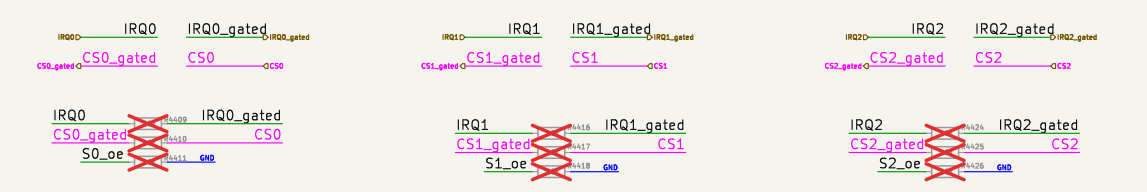

**Brechel Electronic**  
**Industrial Interface Solutions**  
 Designed by Philipp Brechel (Germany)  
[www.be-iis.eu](http://www.be-iis.eu)  
 contact@be-iis.eu

Sheet: /T1S Top/EEE/  
 File: uC\_EEE.kicad\_sch

**Title: Pi-HAT+: EEPROM-Emulation and SPI configuration**

Size: A4 Date: 2026-03-25  
 KiCad E.D.A. 9.0.7

Rev: B  
 Id: 14/6

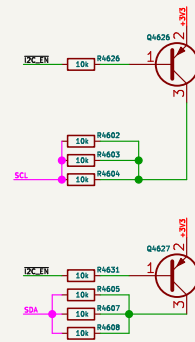
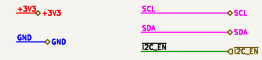

**Brechel Electronic**  
**Industrial Interface Solutions**  
 Designed by Philipp Brechel (Germany)  
[www.be-iis.eu](http://www.be-iis.eu)  
[contact@be-iis.eu](mailto:contact@be-iis.eu)

Sheet: /T1S Top/I2C\_Pull-Up\_EN/  
 File: I2C\_Pull-Up\_EN.kicad\_sch

**Title: Pi-HAT+: I2C Pull-up – switchable**

Size: A4 Date: 2026-03-25

Rev: B

KiCad E.D.A. 9.0.7

Id: 34/6

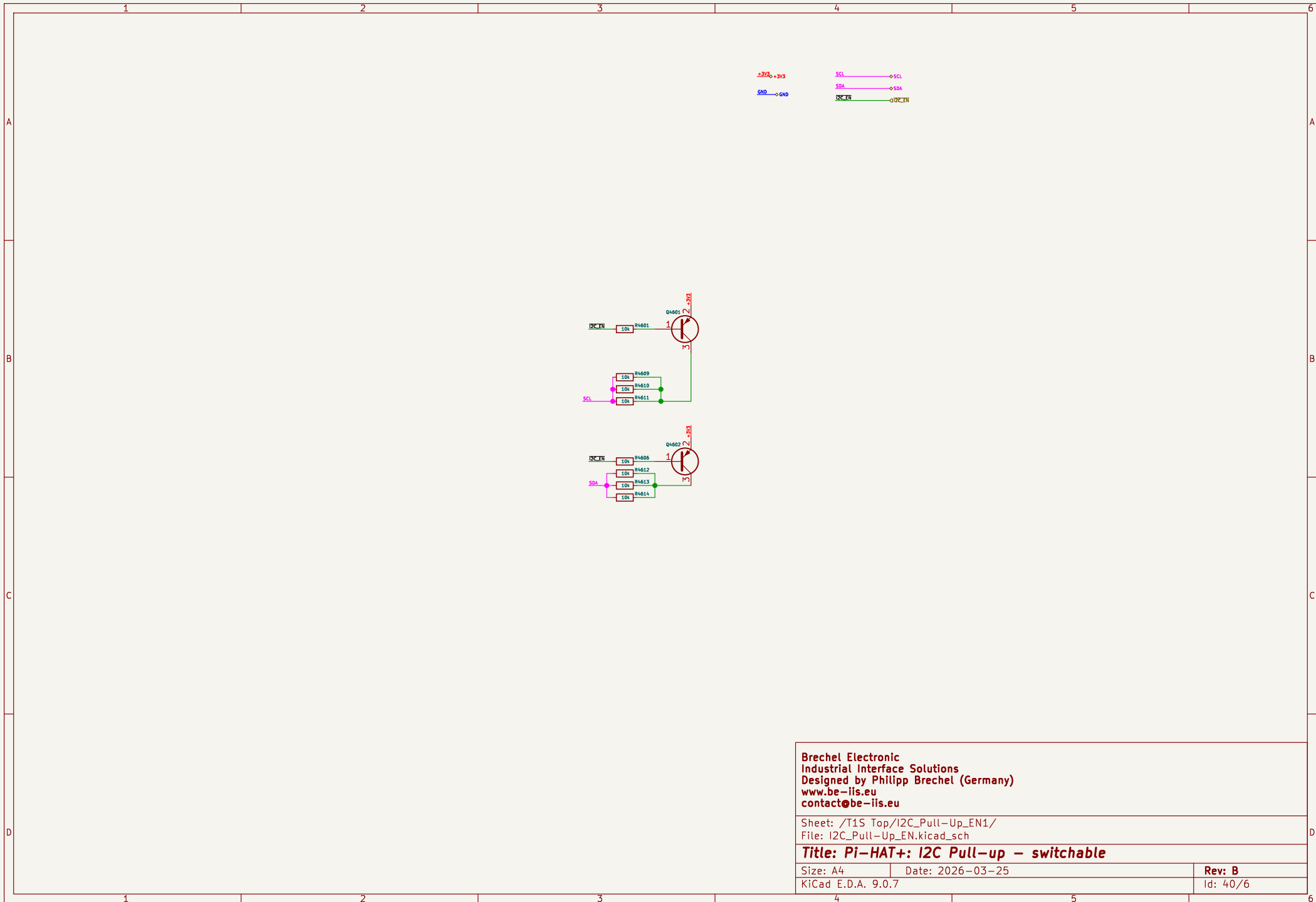

Brechel Electronic  
 Industrial Interface Solutions  
 Designed by Philipp Brechel (Germany)  
[www.be-iis.eu](http://www.be-iis.eu)  
[contact@be-iis.eu](mailto:contact@be-iis.eu)

Sheet: /T1S Top/I2C\_Pull-Up\_EN1/  
 File: I2C\_Pull-Up\_EN.kicad\_sch

**Title: Pi-HAT+: I2C Pull-up – switchable**

Size: A4	Date: 2026-03-25	Rev: B
KiCad E.D.A. 9.0.7		Id: 40/6